

## C7076A/F ADJUSTABLE SENSITIVITY ULTRAVIOLET FLAME DETECTOR

### PRODUCT HANDBOOK

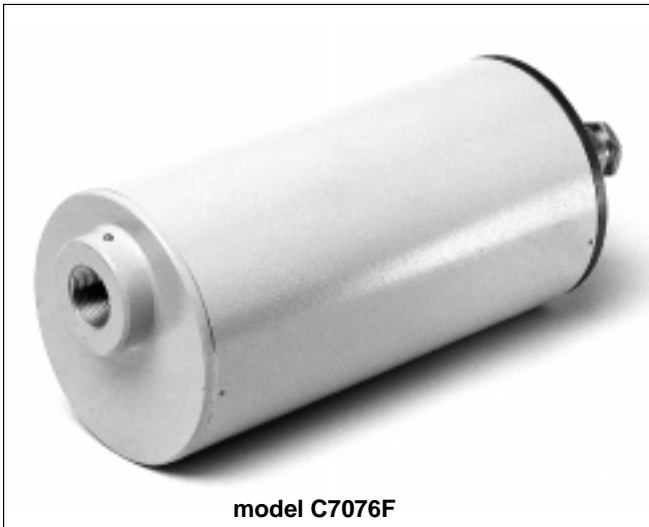

model C7076A



model C7076F

### APPLICATION

The C7076 Ultraviolet Flame Detector is a solid-state, adjustable sensitivity device for sensing the ultraviolet radiation emanating from gas, oil and pulverized coal flames. It is designed for burner management and flame safety systems which require optimum sensitivity and/or flame discrimination.

This flame detector is available in two versions: model C7076A for use in standard applications, and model C7076F for use in installations requiring explosion-proof packaging.

The flame detector is designed for use with either,

- R4348 Flame Switch or,
- R7241 Microcomputer burner control system

or with,

- R7886A\* Dynamic self-check ultraviolet amplifier and,
- 7800 SERIES Burner Programmers

These configurations provide a closed-loop, self-checking circuit which insures the integrity of both amplifier and flame detector. Improper response to simulated flame loss results in a safety shutdown and/or alarm.

\* See Table 2. Applicable flame signal amplifiers on page 4.

## CONTENTS

<b>Description</b> .....	<b>2</b>
<b>Features</b> .....	<b>3</b>
<b>Specifications</b> .....	<b>4</b>
<b>Performance characteristics</b> .....	<b>6</b>
<b>Dimensional drawing</b> .....	<b>7</b>
<b>Planning the installation</b> .....	<b>9</b>
Determine the location .....	9
Radiation sources other than flame .....	9
Single burner requirements .....	9
Sighting angle .....	9
Screening effects .....	10
Multiburner-multifuel requirements .....	10
Parallel flame detectors .....	10
Redundant flame detection system .....	10
<b>Installation</b> .....	<b>11</b>
Selecting and installing sight pipe .....	11
Installing model C7076A .....	11
Installing model C7076F .....	13
Wiring .....	13
<b>Adjustments and checkout</b> .....	<b>14</b>
Flame signal readings .....	14
Sensitivity adjustments .....	14
Ignition spark response test .....	16
Pilot (ignitor) turndown test .....	16
Secure the sight pipe or swivel mount .....	16
Aspirator adjustment (model C7076A only) .....	16
Final checkout .....	16
<b>Troubleshooting</b> .....	<b>17</b>
General .....	17
Equipment required .....	17
Preliminary procedures for model C7076A .....	17
Preliminary procedures for model C7076F .....	17
Troubleshooting procedures for model C7076A and C7076F .....	18
<b>Service</b> .....	<b>20</b>
Periodic maintenance .....	20
Maintenance procedures .....	20
<b>Standards and Approvals</b> .....	<b>23</b>
<b>Ordering information</b> .....	<b>31</b>
<b>Replacement parts and accessories</b> .....	<b>32</b>

## DESCRIPTION

The C7076A and C7076F detector models are identical except for housings.

Model C7076A detector is for use in standard installations. The aluminium and cadmium-plated steel housing meets NEMA 4 standards. It is water-tight and dust-tight, it can be used both indoors and outdoors. There is a 7/8-inch opening in the housing to accommodate a 1/2-inch flexible conduit.

A hinge and quick-release latch allows the detector to swing out for fast and easy cleaning of the integral quartz lens. An aspirator system lengthens the time between cleaning and allows sight pipe seal-off when the detector is swung open. The aspirator has a 1-inch NPT tapping for mounting onto the sight pipe and a 3/8-inch NPT tapping for connecting to the air supply. The detector is mounted on the aspirator by a removable piano hinge.

Model C7076F detector is for use in installations requiring explosion proof packaging. The housing is conform the EExdIIC T6 classification. More details for the explosion proof housing can be found in the chapter Standards and approvals. The C7076F model has a 1-inch NPT tapping for mounting onto a sight pipe.

For allowable mounting positions of model C7076A and model C7076F, see page 9.

The terminal block on both models is of wire clamp type with removable screws (terminal lugs can be used, for model C7076A only) and is situated in the front compartment of model C7076A and in the rear compartment of model C7076F. The rear compartment of model C7076A (front compartment on model C7076F) contains the plug-in electronics chassis including an ultraviolet sensing tube, shutter assembly, power supply, solid state circuitry, sensitivity adjustment controls and flame current meter jack. The chassis plugs into an octal socket in the housing. The detector's entire electronics package slides out for inspection and may be rapidly replaced in the field to keep a critical unit on the line. The C7076 detector has two sensitivity adjustments, labeled A and B – each with a 400:1 dynamic range – that can be set independently and locked to prevent drift due to vibration and an integral flame signal meter jack to facilitate precise sighting.

The high level output of the ultraviolet flame detector permits long distance transmission without special wiring and its solid state circuitry assures long life and stable sensitivity over wide ranges of temperature and voltage. The C7076 detector provides the inherent precision and safety of UV-flame detection while overcoming screening conditions, which reduce the reliability of existing UV detectors.

## FEATURES

- Exceptional sensitivity
- Dual-channel adjustability
- Application flexibility.
- Dynamic self-checking safety.
- Solid state reliability
- Remote sensitivity selection.
- Easy serviceability.

## SPECIFICATIONS

### Models

C7076A: Adjustable sensitivity flame detector packaged in standard housing.

C7076F: Adjustable sensitivity flame detector packaged in explosion-proof housing.

The flame detector is designed for use with either,  
R7476\* Dynamic self-check ultraviolet amplifier and  
– R4348 Flame Switch or,  
– R7241 Microcomputer burner control system  
or with,

R7886A\* Dynamic self-check ultraviolet amplifier and,  
– 7800 SERIES Burner Programmers

\* See Table 2. Applicable flame signal amplifiers on this page

### Maximum aspirator temperature (C7076A only)

107°C (225°F)

### Ambient operating temperature ratings

C7076A: –40 to 70°C (– 40 to +160°F)  
(derate ambient 1°F for every 13°F of aspirator temperature over 160°F).

C7076F: –40 to 70°C (– 40 to +160°F)

### Storage temperature ratings

– 51 to + 85°C (– 60 to + 185°F)

### Air flow requirements (C7076A only)

#### Purge air:

3.3 ml./sec (0.7 SCFM) is required to maintain 102 mm (4 inches) of differential pressure from the aspirator inlet to the combustion chamber. Recommended air flow of 14 ml./sec (3SCFM).

#### Seal-off air:

34.5 kPa (5 psig) maximum combustion chamber pressure.

### Electrical ratings

See table below.

**Table 1. Electrical ratings (model C7076A and F)**

Line Voltage (+10%, –15%)	Frequency (Hertz)	Shutter Voltage*	Maximum Power Consumption**	
			Watts	VA
100	50/60	100	7	14
110 ... 120	50/60	110	7	14
200	50/60	110	7	14
220/240 <sup>1)</sup>	50/60	110	7	14
117 <sup>2)</sup>	50	117	7	14

\* Supplied by the appropriate flame safeguard control operating at the designated line voltage

\*\* Does not include shutter power, which is supplied by the flame safeguard control.

1) 240 Vac for UK only (selectable)

2) For applications in South Africa

### Sensitivity

The C7076 detector can reliably detect a pilot flame (145 W, G25 at 25 mbar) on a distance of 5 m.

### Sensitivity selection

#### Remote sensitivity selection:

External switch wired to select the setting of sensitivity control, either A or B.

### External selector switch:

Must be rated for switching 20 mAmp at 48 Vdc.

### Sensitivity adjustment

#### Range:

400 to 1.

#### Sensitivity controls:

Two, labeled A and B, on plug-in electronics chassis. Each can be set independently and locked to prevent drift due to vibration.

### Flame signal

#### Measured at the flame current meter jack.

C7076 Detector: 1.4 to 5.5 microamps (nominal).

R7476\* Amplifier: 2.5 to 5.5 microamps (nominal).

R7886A Amplifier: 2.5 to 5.5 microamps (nominal).

\* See table 2. below

### Flame signal amplifier

R7476\* Dynamic self-check ultraviolet amplifier

R7886A\* Dynamic self-check ultraviolet amplifier

(order separately)

\* See table 2. below

**Table 2. Applicable flame signal amplifiers**

Type	Response Time	Approval	Burner Controller
R7476A1007 <sup>1)</sup>	2 ... 4s.	FM/UL	BC7000, R4140, R4138, R4075, FSP5075
R7476A1015 <sup>1)</sup>	2s. max.	FM/UL	
R7476B1005 <sup>2)</sup>	3s. max	CE	R4348, R7241
R7476B1013 <sup>2)</sup>	2s. max	CE	
R7886A1001	2.0s/3.0s. <sup>3)</sup>	FM/UL/CE	7800 SERIES

1) Can be used with R7241 and R4348 in a not CE approved application.

2) Can be used with BC7000, R4140, R4138, R4075 and FSP5075 in not CE approved application

3) 2.0 s. when applied with European 7800 SERIES burner programmers.  
3.0s. when applied with North American 7800 SERIES burner programmers (not CE approved)

### Interchangeability

Models C7076A and C7076F are **not** interchangeable with other flame detector models.

### Shutter frequency

1.25 Hz, nominal. Interrupts the line-of-sight of the detector about 75 times per minute to provide self-checking. Any malfunction in the flame detection system results in a safety shutdown.

### Pressure rating of quartz viewing window

C7076A: 138 kPa (20psig) maximum.

C7076F: 500 kPa maximum.

### Dimensions

C7076A: see figure 5.

C7076F: see figure 6.

### Housing

C7076A:

*Construction:* Aluminium and cadmium-plated steel.

*Color:* Ocean blue.

Front compartment contains terminal block; rear compartment contains plug-in electronic chassis.

## C7076F:

Meets requirements (explosion-proof): EEx d IIC T6

*Construction:* Aluminium alloy

*Color:* Ocean blue.

Front compartment contains plug-in electronic chassis; rear compartment contains terminal block

## Enclosure

C7076A: Meets NEMA 4 standards (water-tight and dust-tight, indoor and outdoor)

C7076F: IP65 according to DIN 40050

## Weight

C7076A: 3.3 kg (7.3 lb).

C7076F: 6.3 kg (13.9 lb)

## Mounting and orientation

### C7076A:

Aspirator has 1-inch NPT tapping for mounting onto sight pipe, and 3/8-inch NPT tapping for connecting to the air supply. Detector mounts on aspirator by means of a removable "piano" hinge.

### C7076F:

Detector has 1-inch NPT tapping for mounting onto sight pipe.

For allowable mounting positions of model C7076A and F, see page 9.

## Wiring connections

### C7076A:

Terminal block in front compartment of housing—wire clamp type, removable screws (terminal lugs can be used).

### Cable entry holes:

7/8-inch opening in housing to accommodate 1/2-inch, flexible conduit; fitting must be water-tight to meet NEMA 4 standards.

### C7076F:

Terminal block in rear compartment of housing—wire clamp type.

### Cable entry holes:

Two brass cable glands Ex classification: EExdII, are standard provided in the housing (see Figure 1. ).

### Tightening torque:

- cable gland into rear cover plate: 20 Nm
- cap into cable gland: 3 Nm

### Stopping plug:

Used to close-off unused cable entry holes, Ex classification: EExdII 1 standard supplied with the detector

### Tightening torque:

plug into rear cover plate: 10 Nm

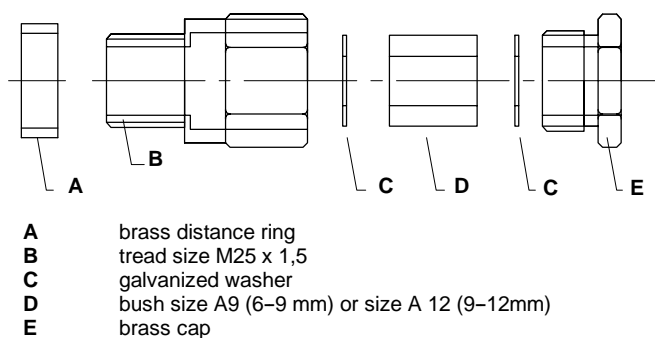

**Fig. 1. Brass cable gland on model C7076F**

## Brass adapter

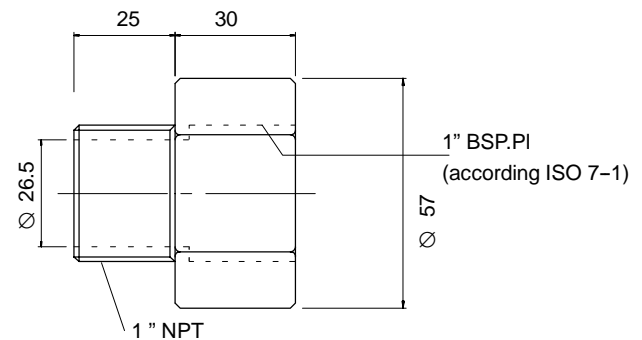

**Fig. 2. Brass adapter 1" NPT to 1" internal pipe thread**

## Maximum cable length

1000 meter between sensor and amplifier

## Plug-in electronic chassis

Field replaceable; plugs into octal in housing. Contains ultraviolet sensing tube, shutter assembly, power supply, solid state circuitry, sensitivity adjustment controls and flame current meter jack. Keyed to housing to ensure proper orientation.

## Operational voltage range

The C7076A/F UV detector will function satisfactory between 85% and 110% of the rated voltage

## Design life

Ultraviolet sensing tube: limited life, see sections Troubleshooting and Service.

## Applicable types of fuel

The C7076 detector has been successfully applied with the following types of fuel:

- Carburized water gas
- Coal gas
- Pulverized coal
- Coke oven gas
- Natural gas
- Naphtha
- Refinery oil liquid/vapor/refined sewage gas
- Acetylene (C<sub>2</sub>H<sub>2</sub>)
- Benzene (C<sub>6</sub>H<sub>6</sub>)
- Butane (C<sub>4</sub>H<sub>10</sub>)
- Ammonia (NH<sub>3</sub>)
- Carbon monoxide (CO)
- Ethane (C<sub>2</sub>H<sub>6</sub>)
- Ethylene (C<sub>2</sub>H<sub>4</sub>)
- Hydrogen (H<sub>2</sub>)
- Hydrogen (H<sub>2</sub> + O<sub>2</sub>)
- Methane (CH<sub>4</sub>)
- Propane (C<sub>3</sub>H<sub>8</sub>)
- JP-4 (jet fuel) (HC)
- Sulfur dioxide (SO<sub>2</sub>)
- Chloride (Cl<sub>2</sub>)
- Fluorine (F<sub>2</sub>)

## PERFORMANCE CHARACTERISTICS

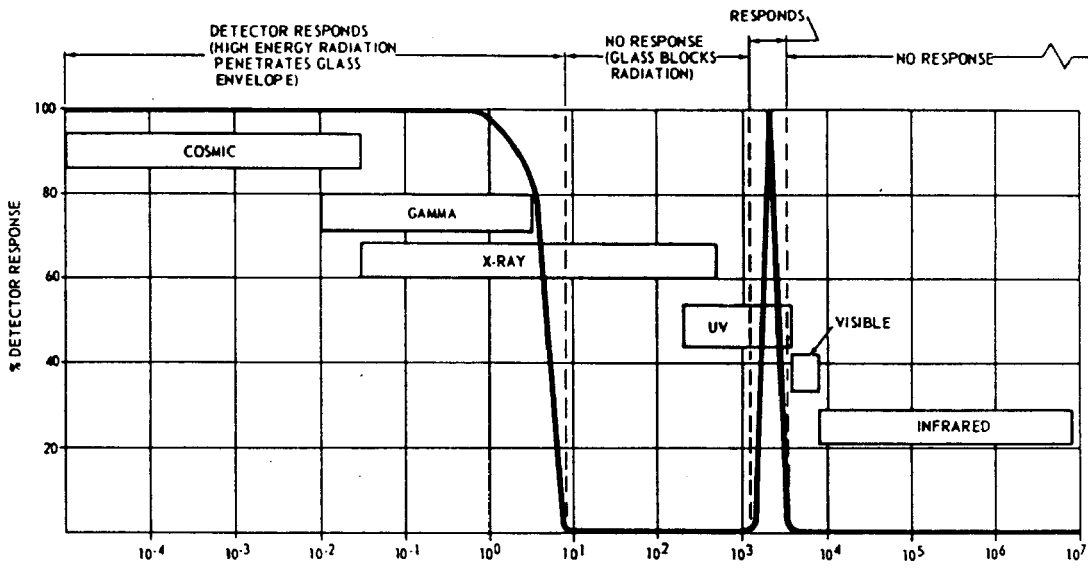

Fig. 3. UV detector response to radiation (1)

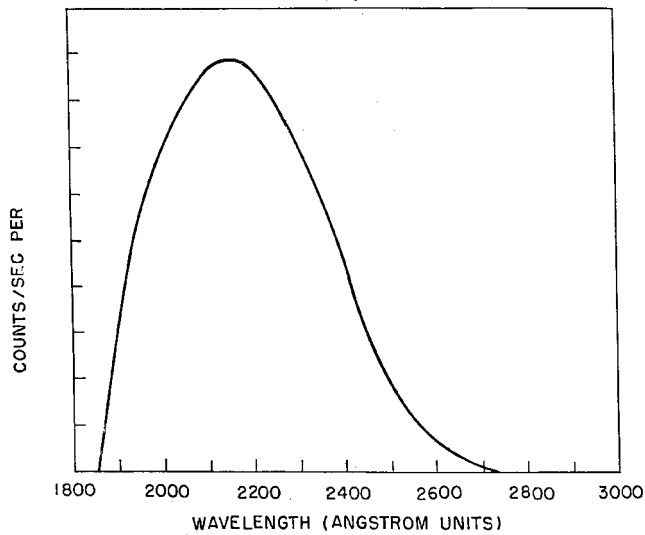
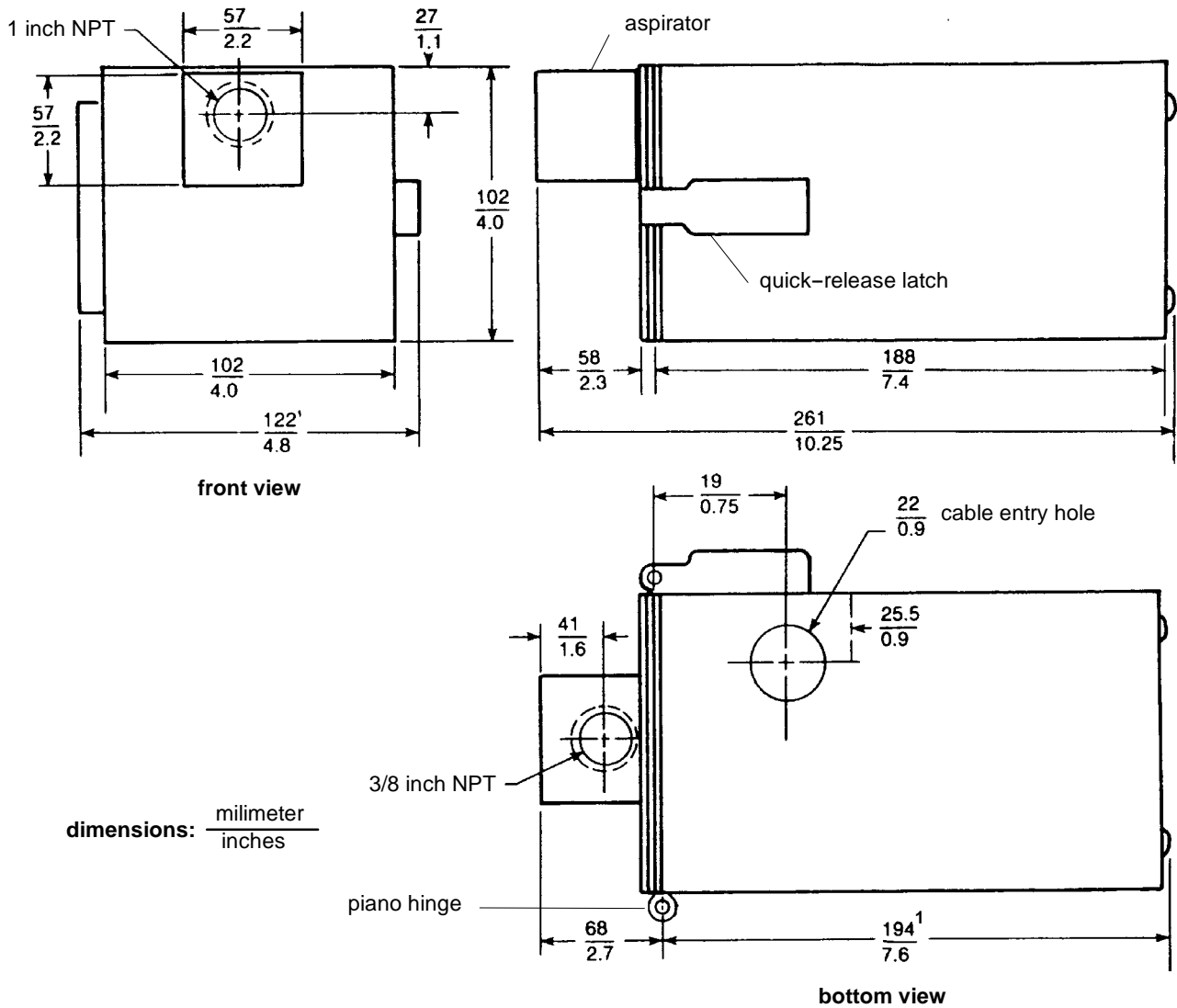

Fig. 4. Spectral response of the UV detector (2)

## DIMENSIONAL DRAWING



NOTE: <sup>1</sup> Allow 228 mm (9 inches) clearance to swing out the detector for lens cleaning or servicing

Fig. 5. Dimensional drawing C7076A



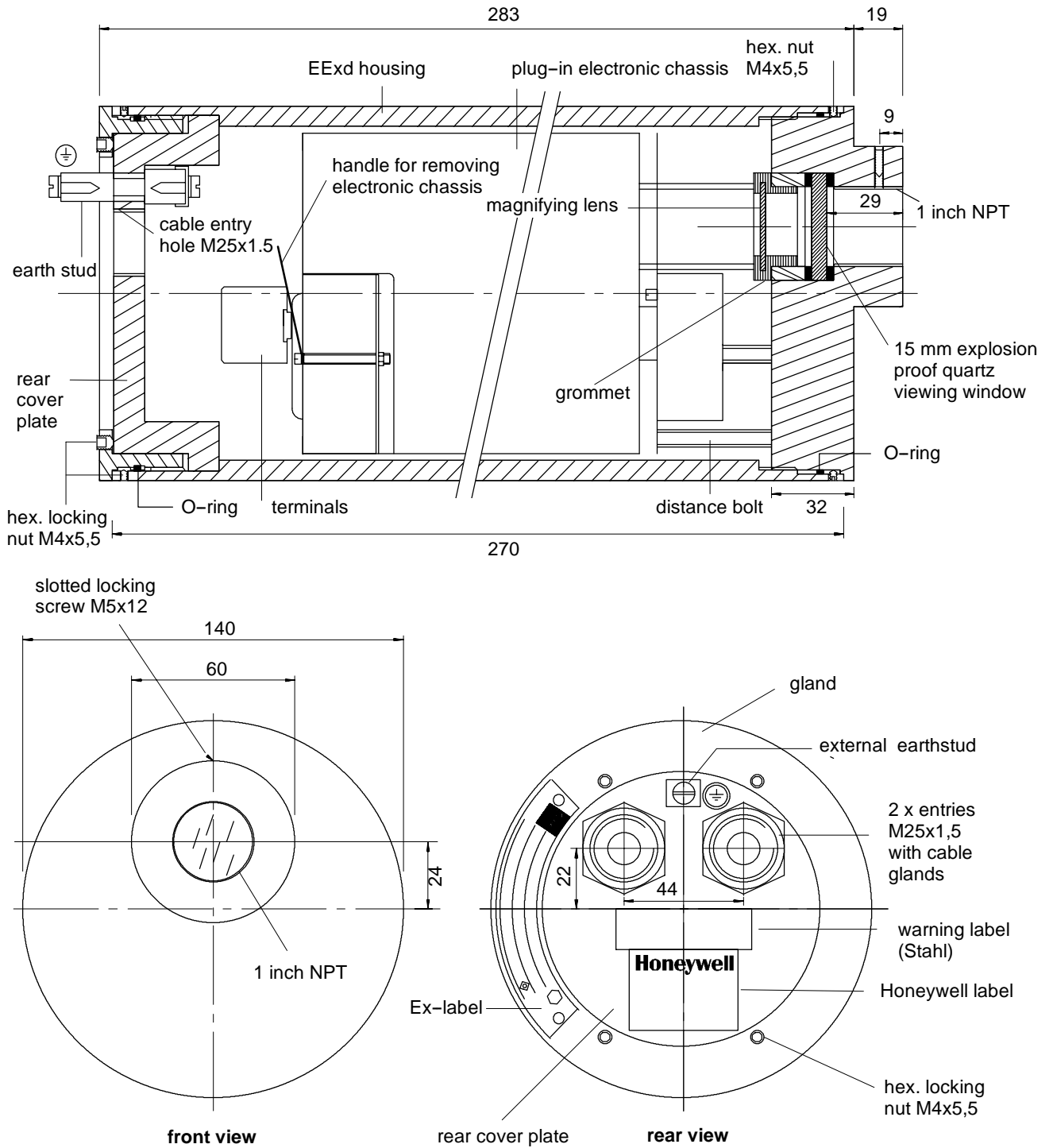

Fig. 6. Dimensional drawing C7076F

## PLANNING THE INSTALLATION

Proper flame detector application is the basis of a safe and reliable flame safeguard installation. Refer to the burner manufacturer's instructions as well to those included here. Follow all instructions carefully.

### Determine the location

Before beginning the actual installation, estimate the best location for mounting the detector based upon these factors:

#### 1. Temperature

Install the flame detector where the surrounding temperature will remain within the specified ambient operating temperature ratings.

For the C7076A, to keep the detector temperature within specifications, the aspirator temperature must not exceed 107°C (225°F). If the aspirator temperature will exceed temperature ratings, the introduction of cooling–purging air will be required.

#### 2. Vibrations

Do not install the detector where it could be subject of excessive vibration; it shortens the life of the electronic components. Vibrations with a magnitude greater than 1g will require an anti–vibration mount to cushion the detector.

#### 3. Orientation

When assembling the detector, make sure that the viewing window of the detector is facing upwards. Mount the detector horizontal or to a maximum of 90 degrees from horizontal, as indicated in the picture below.

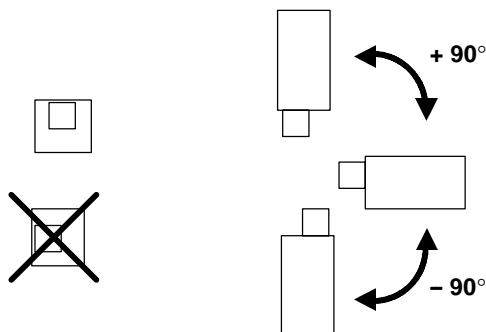

#### 4. Clearance

Make sure there will be enough room to swing out the detector for servicing (refer to Figure 5.)

### Radiation sources other than flame

Examples of radiation sources, other than flame, which could actuate the detection system:

#### Ultraviolet sources

- Radiant surfaces above 1200°C (2200°F).
- Sparks from ignition transformers and welding arcs.
- Gas lasers
- Sun lamps
- halogen lamps
- Germicidal lamps
- Incandescent lamps held close to the sensing tube filament above 2200°F).

#### Gamma ray and X-ray sources

- Diffraction analyzers
- Electron microscopes
- Radiographic X-ray machines
- High voltage vacuum switches
- High voltage condensers
- radioisotopes

Except under very unusual circumstances, none of these sources, except a radiant surface or ignition spark, would be present in or near the combustion chamber. The detector *may* respond to a radiant surface at a temperature above 1200°C (2200°F) if both of these conditions are present:

1. the detector sensitivity control is set at (or near) maximum,
2. the surface represents a significant percentage of the detector's field view.

If the temperature or a radiant surface causes the flame relay (in the flame safeguard control) to pull in, re–aim the sight pipe so the detector views a cooler area, or decreases the sensitivity of the detector.

Ignition sparks is a rich sources of ultraviolet radiation.

#### IMPORTANT

*When installing the detector, make sure it does not respond to ignition spark.*

### Single burner requirements

The detector must have an unobstructed view of the flame it is supervising under all firing conditions. This implies a proper sighting angle and the minimization of screening effects.

### Sighting angle

The first 30 percent of a flame (the root) radiates the most intense ultraviolet energy. The low angle sighting permits the detector to view a greater depth of the flame root, thus reducing the effects of irregularities in the flame pattern. The best sighting angle is nearly parallel to the axis of the flame, as shown in Figure 5.

NOTE: When possible, it is desirable to tilt the detector and sight pipe *downwards* to prevent the build up of soot in the pipe or on the viewing lens.

In most installations, the detector will need to respond to the pilot flame alone, then to the pilot and main burner flame together and finally to the main burner flame alone. The detector must meet all sighting requirements which apply:

1. Pilot flame alone – the smallest pilot flame that can be detected must be capable of reliable ignition the main burner.
2. Pilot and main burner flame together – the detector must sight the junction of both flames.
3. Main burner flame alone – the detector must sight the most stable part of the flame for all firing rates

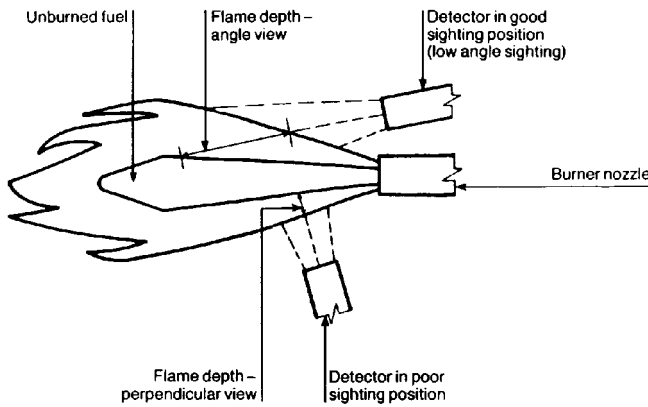

**Fig. 5. Sighting angle**

## Screening effects

Smoke, fuel mist, dirt and dust are masking agents that absorb ultraviolet radiation from the flame. They create a screen that reduces the amount of ultraviolet radiation reaching the detector and may cause flame signal deterioration resulting in a shutdown. The adverse affects of screening may be minimized by proper burner adjustment, increasing the detector viewing area (shorten sight pipe and/or increase its diameter) and optimizing detector sensitivity.

## Multiburner-multifuel requirements

In addition to meeting the requirements for a single burner, a multiburner installation also requires flame discrimination. *Flame discrimination may be defined as the location of all flame detectors such that each detector responds only to the flame(s) produced by the burner it is supervising.*

### Multiburner requirements

In multiple burner systems, not every detector can be positioned so its line of sight does not intercept flames from other burners. This situation occurs in front-fired boiler furnaces having more than one row of burners, or in multilevel opposed-fired furnaces where the burners face each other.

When planning such an installation, *locate each flame detector so that it has the best possible view of the root of the flame(s) it is supervising and the worse possible view of all other flames.*

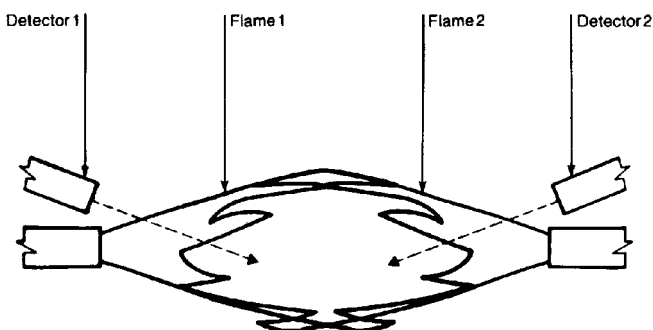

**Fig. 6. Critical detector application problem**

Figure 6. illustrates a critical detector application problem requiring flame discrimination. Flame discrimination is accomplished by detector 1 by reducing its sensitivity until the flame relay (in the flame safeguard control) does not respond to flame 2. Note that detector 1 is aimed at the root of Flame 1 where UV (ultraviolet) energy is most intensive. Although it sights flame 2 is not aimed at the root of flame 2. The sensitivity of detector 1 is reduced to a point that ensures maximum sensitivity to flame 1 while rejecting flame 2. Similarly, Detector 2 is adjusted to ensure maximum sensitivity to Flame 2 while rejecting Flame 1. If the sensitivity control on a detector is set at its minimum position and flame discrimination cannot be achieved, insert an orifice plate in the sight pipe. An orifice of the proper diameter will reduce the ultraviolet radiation reaching the detector so that the sensitivity can be adjusted to effect flame discrimination.

### Multifuel requirements

Detectors supervising burners that alternately fire more than one fuel may require a different sensitivity level for each fuel. For example, a higher sensitivity is required to reliable sense pulverized coal or No. 2 fuel oil in contrast to natural gas or to No. 2 fuel oil. Reliable flame sensing and flame discrimination may not be maintained simultaneously (without changing the sensitivity setting) when alternating between two fuels. The C7076 has two integral sensitivity adjustments that can be remotely and automatically selected. The two sensitivity adjustments can be chosen by means of the fuel selector switch (refer to Remote Sensitivity Selection in the installation section). The sensitivity adjustments should be made for both fuels as described in the section on multiburner requirements, using one adjustment pot for each fuel.

### Parallel flame detectors

Two C7076 detectors can be connected in parallel to the same flame signal amplifier and still provide independent sensitivity adjustment. This capability is particular useful for multiburner, multifuel applications.

Shifting flame patterns, commonly encountered on burners with wide turndown ratios, may require parallel detectors to prove the flame at the highest and lowest firing rates. In this case, one detector supervises the pilot (interrupted) and both detectors supervise the main burner flame. During the main burner "run" period, either detector is capable of maintaining system operation.

In addition to assuring more reliable flame detection, parallel detectors facilitate maintenance during burner operation. Each detector can be removed in turn without shutting down the supervised burner. However, a flame simulating failure occurring in the flame signal amplifier or in either detector will cause a shutdown.

### Redundant flame detection system

Two C7076 detectors connected to *two* flame signal amplifiers wired in parallel comprise a *redundant* flame detection system. In addition to the features of parallel flame detectors, a redundant system increases reliability and is therefore recommended for critical burner applications. *A flame failure, flame signal loss, or flame simulating failure occurring in either detector subsystem will cause an alarm (not a shutdown), allowing corrective action to avert a shutdown.*

## INSTALLATION

### ⚠ CAUTION

1. Installer must be a trained, experienced flame safeguard control serviceman
2. Disconnect power supply before beginning installation to prevent electrical shock and equipment damage.
3. All wiring must comply with applicable local electrical codes, ordinances and regulations.
4. Voltage and frequency of power supply connected to this detector must agree with the values marked on the detector.
5. If an air supply is connected to the aspirator on model C7076A, its pressure must equal or exceed that required to seal off the detector from the combustion chamber.
6. On multiburner installation, each detector must respond only to the flame(s) produced by the burner it is supervising.
7. Do not connect more than two detectors in parallel to a single R7476\* or R7886A\* Dynamic self-check ultraviolet amplifier.
8. Perform all required adjustments and checkout tests after installation is complete.

\* See Table 2. Applicable flame signal amplifiers on page 4.

### Selecting and installing sight pipe

After you have determined the approximate location and sighting angle, select the sight pipe. A black iron pipe is recommended to provide reliable flame sensing. Stainless steel and galvanized pipes have bright surfaces that initially transmit ultraviolet radiation very well. However their ability to transmit UV will decay when the bright surface becomes dull with age or contamination and flame detection will become less reliable with time.

The aspirator on the faceplate of model C7076A and front cover plate of model C7076F, both, are tapped for 1-inch NPT threaded pipe. A larger pipe may be necessary to obtain proper performance; any diameter other than 1-inch will require a reducer coupling (see Figure 8.). The geometry of the sight pipe affect the performance of the detector. If the flame signal is too small, reduce the length or increase the diameter of the pipe to increase the field of view of the detector. If a sight pipe is longer than 1 foot (approx. 30 cm.) is required, use a 2-inch diameter pipe with the reducer as close to the detector as possible.

Cut a hole of the proper diameter for the sight pipe in the burner front or windbox at the selected location. The hole should be at least 2 inches in diameter to allow adjustment of the sighting angle. If register vanes interfere with the desired line of sight, trim the interfering vane(s) to assure an unobstructed view of the flame.

Cut the pipe to the desired length. Thread one end of the pipe to fit the desired matching component; i.e., aspirator on faceplate of model C7076A (see Figure 7., 8., 9. or 13. as applicable). Insert the other end of the pipe into the

mounting hole, align it to the desired sighting angle and tack weld it in position.

NOTE: When initially mounting the sight pipe, *tack weld* it in place to allow further sighting adjustments. Make sure the tack weld will support the weight of the detector when installed.

NOTE: When installing model C7076A, a Honeywell 118367A Swivel mount is recommended to facilitate sighting the flame properly. For installation instructions, see form 60-0361

### Installing model C7076A

#### Mounting aspirator

The aspirator on the faceplate of Model C7076A screws directly onto the 1 inch NPT threaded pipe (see Figure 7. Use a crescent wrench to tighten the aspirator onto the pipe. For alternate mounting methods and further information, refer to Figure 8. or 9.

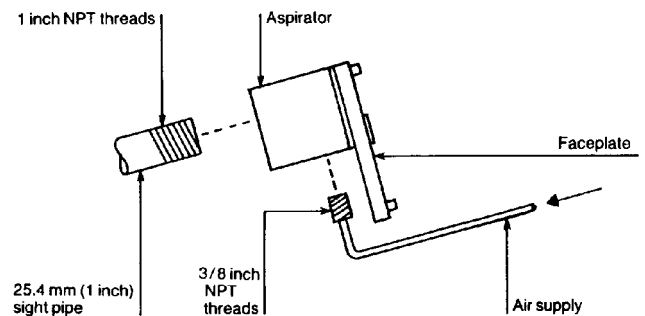

Fig. 7. Direct mounting

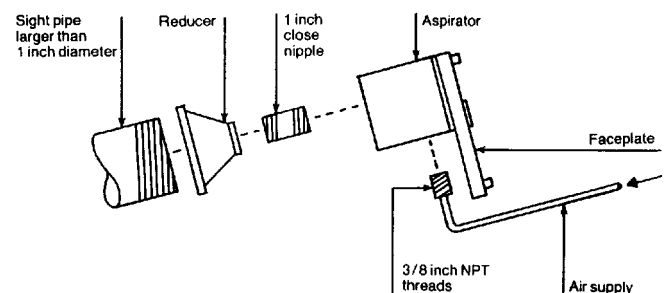

Fig. 8. Using a reducer for larger pipes

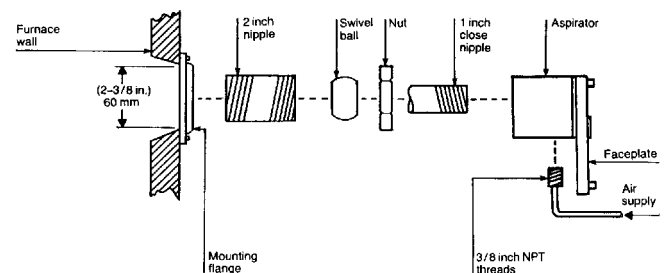

Fig. 9. Using a swivel mount

## Mounting detector

Mount the detector on the faceplate by placing the detector on its hinge and inserting the hinge pin. Install the 1/2-inch flexible conduit to detector as follows:

1. Loosen the 4 captive screws in the front cover plate (with the viewing lens and remove the plate).
2. Install a cable gland. To meet NEMA 4 standards, use water-tight conduit and a water-tight cable gland (such as an Appleton ST50 Liquid-Tight Connector with an STG-50 neoprene "O" ring and steel gasket assembly).

**Table 3. Applicable cable glands**

Manufacturer	Coupling No.	"O" Ring No.
T&B	5232	5262
Efcor	11-50	LTG-1
Raco	3402	2452
Steel City	LT-101	LR-531
Crouse Hines	LT-50	SG-1

## Connecting air supply (optional)

Use a flexible air supply line which will allow repositioning of the sight pipe until the permanent detector position has been verified.

The aspirator air inlet can be plugged, left open or connected to a clean (oil/moisture-free) air supply. Use a 3/8-inch NPT connector if aspirator air is used (see figure 9. ). The aspirator allows air to flow through the sight pipe into the combustion chamber to cool, clean and seal off the sight pipe. The airflow eliminates the need for frequent lens cleaning. Refer to Figure 10. for purge air requirements.

Seal off the sight pipe prevents hot gases from escaping from a positive pressure combustion chamber when the detector is swung open on its hinge for maintenance. Refer to figure 11. for the minimum inlet pressure or air flow required to seal off a sight pipe against a positive combustion chamber pressure.

Figure 12. shows a method of supplying a constant airflow to purge the sight pipe, while also providing enough pressure to seal off the sight pipe when needed.

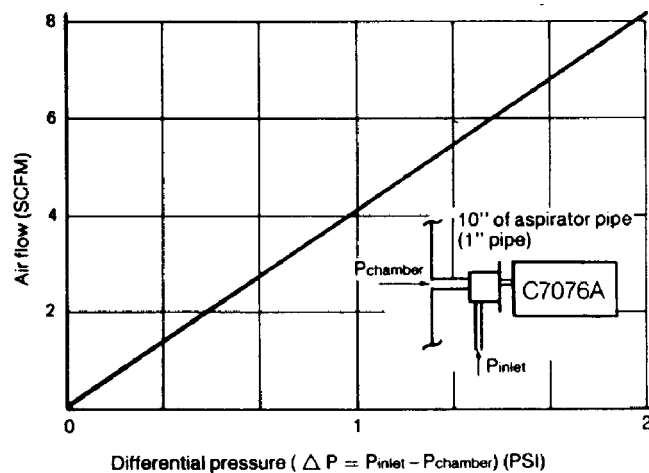

**Fig. 10. Purge air requirements**

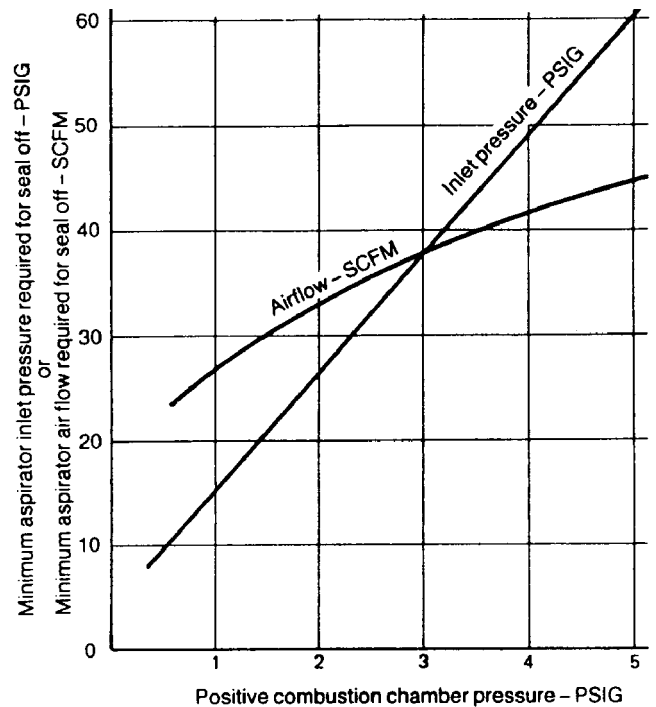

**Fig. 11. Minimum inlet pressure or air flow required to seal off the sight pipe**

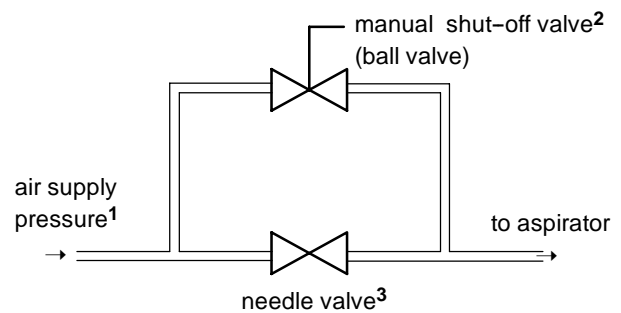

<sup>1</sup> Equals or exceeds the pressure required to seal off the sight pipe from a positive pressure combustion chamber.

<sup>2</sup> Open only when servicing the detector.

<sup>3</sup> adjust to provide enough air to cool the aspirator and maintain a clear sight pipe. remove handle after adjusting.

**Fig. 12. Constant airflow supply to purge the sight pipe**

## Installing model C7076F

### IMPORTANT

*Non-hardening grease must be used between any screw thread and its tapped opening, to prevent corrosion on any metal-to-metal joints of the detector.*

### Mounting detector

The front cover plate of model C7076F screws directly on the 1 inch NPT threaded pipe (see figure 13. ). Screw the detector onto the pipe; hand tighten in place, making sure that the viewing window of the the detector is facing upwards. Lock the position of the detector with the slotted locking screw on top of the 1 inch tapping

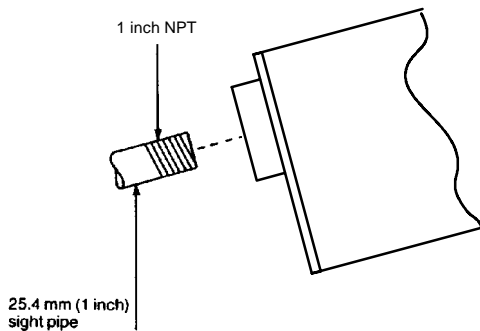

Fig. 13. Model C7076F; direct mounting

## Wiring (model C7076A and F)

### Type of wire

All wiring must comply with applicable electrical codes, ordinances and regulations. When wiring model C7076A or C7076F, you need not consider lead wire length shielding, separate conduits or other special requirements.

### Wiring diagram

Follow approved system wiring diagrams below.

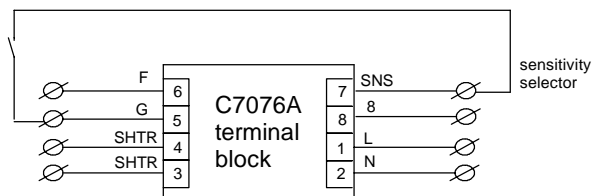

- 1 = Line (L) 220/110/100\* Vac
- 2 = Neutral (N)
- 3 = SHTR (shutter), 110/100\* Vac
- 4 = SHTR (shutter), 110/100\* Vac
- 5 = G (ground)
- 6 = F (flame)
- 7 = SNS (sensitivity selector)
- 8 = Line (L) 240\*\* Vac
- \* depends on O.S. Number
- \*\* for 220/240 Vac model only

Fig. 14. Wiring diagram C7076A

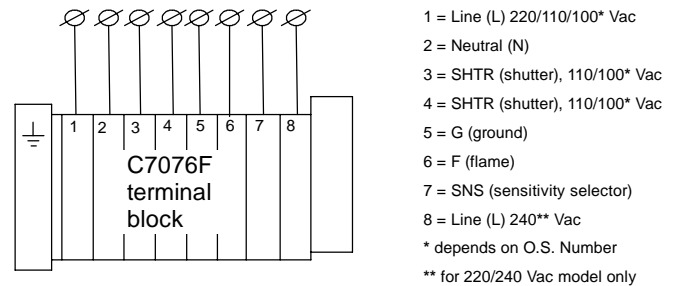

Fig. 15. Wiring diagram C7076F

### Remote sensitivity selection

For systems with burner firing more than one fuel, each with a different level of UV emission, or whose flame pattern change with firing rate, two sensitivity adjustments are provided. An external selector switch (SPST) is required to choose between the two sensitivity settings. (refer to Sensitivity adjustments in the Adjustments and Checkout section.) With the external switch *open*, the sensitivity control A setting will determine the sensitivity of the detector; with the switch *closed*, the sensitivity control B setting will determine sensitivity.

For automatic sensitivity selection, the switch may be incorporated into fuel selector switch or the firing rate switch.

### Connecting detectors in parallel.

Two C7076A or two C7076F flame detectors *with the same voltage rating* can be connected in parallel to the same terminals. To avoid exceeding the rating of the shutter control circuit, *do not connect more than two detectors parallel.*

### Making the connections

1. Provide access to the terminal block in detector as follow:
  - a. For Model C7076A, swing open detector from faceplate. Loosen the 4 captive screws that secure the cover plate (with the magnifying lens) to the detector and remove the plate to provide access to the terminal block of the detector.
  - b. For Model C7076F, loosen the 2 hexagon locking nuts of housing and the 4 hexagon locking nuts of the gland, which secures the rear cover plate of the detector. Turn the gland counter-clockwise, making sure that the rear cover plate with the cable glands stay in place to provide access to terminal block of the detector.
2. Run the wires from the flame safeguard control through the cable glands to the C7076A or C7076F detector.
3. Connect each wire to the proper terminal on the terminal block (refer to Figure 14. or Figure 15. , as applicable).
4. Reassemble detector by performing step 1.a or 1.b above, as applicable, in reverse.

## ADJUSTMENTS AND CHECKOUT

### CAUTION

Before initial burner light-off, consult the burner/boiler manufacturer's instructions and the sequence of operation for the burner management system.

### Flame signal readings

The final sighting position of the C7076A or C7076F may be most readily determined by using a Honeywell W136A Test Meter or other applicable device connected to the FLAME CURRENT meter jack on the plug-in electronic chassis (see figure 17.) This output is the unprocessed flame signal from the detector and is intended as a diagnostic aid. Readings taken at the detector will facilitate installing the detector in the best sighting position by pinpointing the region of greatest UV intensity for a given flame.

Figure 16. illustrates the relationship between detector and amplifier readings. Detector saturation (the point at which an increase in UV intensity does not produce a noticeable increase in flame signal strength) occurs at point A. B represents the point at which the amplifier is saturated while the minimum UV intensity required for system operation is at C.

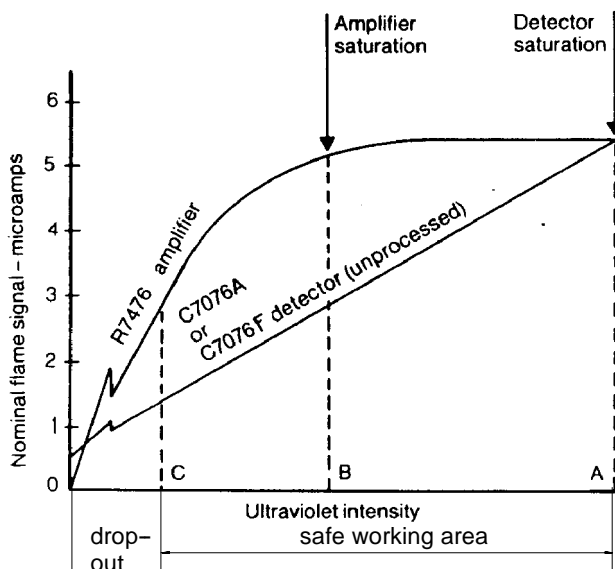

**Fig. 16. Relationship between detector and amplifier readings**

The linearity of the detector output curve shows that a unit increase in ultraviolet intensity is accompanied by a corresponding increase in flame signal strength. This condition facilitates pinpointing the location of the most intense ultraviolet radiating from a flame. Thus, by locating the optimum flame signal with the detector, the peak ultraviolet signal and therefore the most reliable reading, is obtained.

The minimum acceptable stable flame signal readings are:

C7076A and C7076F flame detectors:	1.4 microamps.
R7476* Flame Signal Amplifier:	2.5 microamps.
R7886A* Flame Signal Amplifier:	2.5 microamps

\* See Table 2. Applicable flame signal amplifiers on page 4.

### Sensitivity adjustments

#### General considerations

1. If a single detector is required to supervise both the pilot and main burner flame, verify the flame signal for each flame individually.
2. Make sure the minimum acceptable *stable* flame signal (1.4 microamps at the detector, or 2.5 microamps at the amplifier) is obtained throughout the entire turndown range of the burner.
3. Parallel detectors may be required if a single sighting angle will not provide a proper flame signal for both the pilot and the main burner throughout the entire turndown range of the burner.

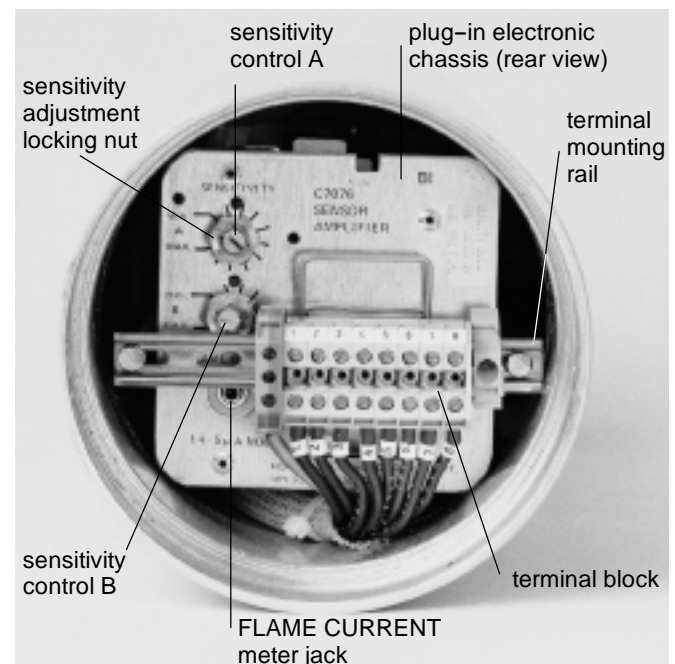

**Fig. 17. Sensitivity adjustments**

#### Single burner system using model C7076A

1. Loosen the 4 captive screws in the rear cover plate of the C7076A and remove the plate
2. Adjust sensitivity control A for maximum sensitivity
  - a. If the remote sensitivity selection feature is used, make sure the external selector switch is *open* for control A adjustment.
  - b. Loosen the set point locking nut on sensitivity control A.
  - c. Turn the control clockwise to MAX. position
  - d. Tighten the set point locking nut 1/4 turn past "hand tight" (*do not over-tighten*).
3. Read the flame signal in microamps at the FLAME CURRENT meter jack.
  - a. Use a Honeywell W136A test meter with the selector switch at the SPL position, or use a microammeter with a 0 to 25 microamp dc range, shunted with a 50 microfarad capacitor.
  - b. A 117053 meter connector plug is needed (supplied with the W136A or it may be ordered separately). Connect its red spade tip to the red (+) meter lead and its black spade tip to the black (-) meter lead.

- c. Insert the plug into the FLAME CURRENT meter jack and allow a few seconds for the meter reading to stabilize.
  - d. Read the average *stable* current, disregarding the peaks due to shutter operation.
4. Optimize the flame signal.
    - a. Observe the flame signal while varying the line of sight of the detector.
      1. Swivel the detector if it is mounted on a Honeywell 118367A swivel mount, or
      2. Adjust the angle and/or position the sight pipe (which was only tack welded as previously instructed).
    - b. Try several sighting angles until you obtain the highest and most stable meter reading possible. (If it is less than 1.4 microamps, refer to the Troubleshooting section).
    - c. Repeat step b. for both the pilot and the main burner flame. Do not sacrifice the main flame signal to obtain unnecessarily high pilot flame signal.
  5. Repeat step 2. and 3. for sensitivity control B, if used. make sure the external selector switch is *closed* while adjusting control B.
  6. Secure the swivel mount (if used), or tack weld the sight pipe. *Do not weld the sight pipe permanently into place until you have completed the spark hold-in and pilot turndown tests (see page 16).*
  7. Remove the plug from the FLAME CURRENT meter jack.
  8. Replace the rear cover plate and tighten the 4 screws securely.

#### Multiburner system using model C7076A (Flame discrimination)

1. Complete steps 1. through 8. under "Single burner system" above for each burner.
2. With all "A" sensitivity controls set to MAX. position and all burners firing at full load, select one burner and proceed as follows:
  - a. Shut down the chosen burner, then note the flame signal reading.
  - b. Loosen the locking nut on sensitivity control A.
  - c. Gradually reduce the sensitivity by turning control A counter-clockwise until the flame relay (in the flame safeguard control) drops out.
  - d. Relight the burner and note the flame signal reading. The difference between the new reading and the initial reading in step 2a., represents the degree of flame discrimination
  - e. repeat the "run-shutdown-dropout" procedures (step 2a.-d.) until the optimum setting has been achieved.
  - f. "Hand tighten" the locking nut on a detector sensitivity A – then tighten another 1/4 turn, but do *NOT* overtighten.

**NOTE:** If the sensitivity control on a detector is reduced to MIN. position and flame discrimination cannot be achieved, insert an orifice plate in the sight pipe. An orifice of the proper diameter will reduce the ultraviolet radiation reaching the detector so that the sensitivity can be adjusted to effect flame discrimination.

3. Repeat step 2. for sensitivity control A on each burner.

4. Repeat step 2. for sensitivity control B (if used) on each burner. Verify that sensitivity control A and B on each detector are properly indexed by the system fuel selector, firing rate switch, etc.

#### Multifuel systems

For multifuel systems, use one sensitivity control for each fuel type. Follow step 2. and 3. above for each fuel type

#### Single burner system using model C7076F



## WARNING

Ensure that the environment surrounding the C7076F is free of all explosive or hazardous conditions before exposing the interior of the detector to the atmosphere during performance of the following adjustment procedures:

1. Loosen the 2 hexagon locking nuts of housing and the 4 hexagon locking nuts of the gland, which secures the rear cover plate of the detector. Turn the gland counter-clockwise, making sure that the rear cover plate with the cable glands stays in place to provide access to terminal block of the detector.
2. Adjust sensitivity control A for maximum sensitivity.
  - a. If the remote sensitivity selection feature is used, make sure the external selector switch is *open* for control A adjustment.
  - b. Turn sensitivity control A to MAX. position.
3. Read the flame signal in microamps at the FLAME CURRENT jack.
  - a. Use a Honeywell W136A test meter with the selector switch at the SPL position or a microammeter with a 0 to 25 microamp dc range, shunted with a 50 microfarad capacitor, may be used.
  - b. A 117075 meter connector plug is needed (supplied with W136A or it may be ordered separately). Connect its red spade tip to red (+) meter lead and its black spade tip to the black (-) meter lead
  - c. Insert the plug into the FLAME CURRENT meter jack and allow a few seconds for the meter reading to stabilize.
  - d. Read the average *stable* current, disregarding the peaks due to shutter operation.
4. Optimize the flame signal.
  - a. Observe the flame signal while varying the line of sight of the detector. Adjust the angle and/or position of the sight pipe (which was only tack welded as previously instructed).
  - b. Try several sighting angles until you obtain the highest and most stable meter reading possible. (If it is less than 1.4 microamps, refer to the Troubleshooting section).
  - c. Repeat step b. for both the pilot and the main burner flame. Do not sacrifice the main flame signal to obtain unnecessarily high pilot flame signal.
5. Repeat step 2. and 3. for sensitivity control B, if used. Make sure the external selector switch is *closed* while adjusting control B.
6. Secure the swivel mount (if used), or tack weld the sight pipe. *Do not weld the sight pipe permanently into place until you have completed the spark hold-in and pilot turndown tests (see page 16)*
7. Remove the plug from the FLAME CURRENT meter jack.



8. Reassemble detector by performing step 1. above, in reverse.

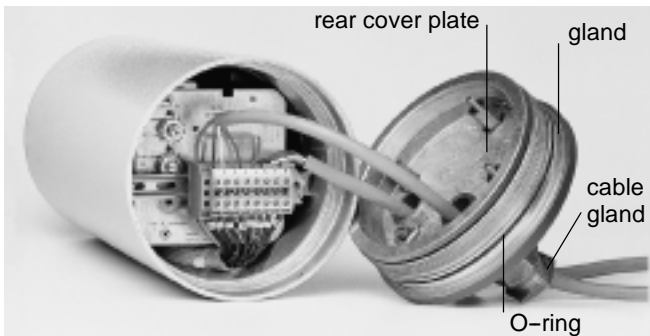

**Fig. 18. C7076F rear cover plate removed**

**Multiburner system using model C7076F (Flame discrimination)**

1. Complete steps 1. through 8. under "Single burner system using model C7076F" above for each burner.
2. With all sensitivity controls A set to MAX. position and all burners firing at full load, select one burner and proceed as follows:
  - a. Shut down the chosen burner, then note the flame signal reading.
  - b. Gradually reduce the sensitivity by turning control A counter-clockwise until the flame relay (in the flame safeguard control) drops out.
  - c. Relight the burner and note the flame signal reading. The difference between the new reading and the initial reading in step a., represents the degree of flame discrimination
  - d. Repeat the "run-shutdown-dropout" procedures (step 2a.-d.) until the optimum setting has been achieved.

**NOTE:** If the sensitivity control on a detector is reduced to MIN. position and flame discrimination cannot be achieved, insert an orifice plate in the sight pipe. An orifice of the proper diameter will reduce the ultraviolet radiation reaching the detector so that the sensitivity can be adjusted to effect flame discrimination.

3. Repeat step 2. for sensitivity control A on each burner.
4. Repeat step 2. for sensitivity control B (if used) on each burner. Verify that sensitivity control A and B on each detector are properly indexed by the system fuel selector, firing rate switch, etc.

**Multifuel systems**

For multifuel systems, use one sensitivity control for each fuel. Follow step 2. and 3. above for each fuel.

**Ignition spark response test**

An ignition spark response test must be done for all detectors to ensure that ignition spark will not actuate the flame relay in the flame safeguard control. The test is done by manually closing all fuel valves, starting the system, and observing the flame relay when ignition comes on. If the flame relay pulls in, the detector must be repositioned to eliminate the response to ignition spark.

**Pilot (ignitor) turndown test**

A pilot (ignitor) turndown test must be done for all applications in which the detector must prove the pilot before the main fuel valve can open. This test proves that the smallest pilot flame which can be hold in the flame relay (in the flame safeguard control) is also capable of safely ignition the main burner. The test consists of closing the main valve, reducing the pilot flame until it is just able to hold in the flame relay and then opening the main fuel valve to verify a safe main burner light off.

**Secure the sight pipe or swivel mount**

When the flame signal is acceptable and all adjustments have been made, remove the detector and secure the sight pipe (or swivel mount):

Weld the sight pipe in its final position

or,

Tack weld the swivel ball in place in its socket if using a Honeywell 118336A swivel mount.

Then, reinstall the detector.

**Aspirator adjustment (model C7076A only)**

Make the final connections and adjustments of the optional air supply (if used). Refer to the paragraph entitled "Connecting air supply")

**Final checkout**

Before putting the burner(s) into service, check out the installation using procedures in the Checkout section of the instruction sheet for appropriate flame safeguard control. After completing the checkout, run the burner(s) through at least five complete cycles to verify proper operation.

## TROUBLESHOOTING

### CAUTION

1. Use utmost care while troubleshooting the detector, line voltage is present on some of the terminals when power is on.
2. Open the master switch before removing or installing the plug-in electronics chassis of the detector.

#### General

If you can't obtain a satisfactory flame signal while adjusting the sensitivity, refer to the Preliminary and Troubleshooting procedures that follow. If you encounter other problems in the system, refer to the Troubleshooting section in the instruction sheet for the appropriate flame safeguard control.

Upon completion of troubleshooting, be sure to perform the Adjustment and Checkout procedures previously specified for the detector.

NOTE: Instructions for replacing the viewing lens, sensing tube, coil and shutter assembly and plug-in electronic chassis are given in the Service section.

Before making a replacement, make sure you have the correct part (check its part number and voltage rating)

#### Equipment required

1. Voltmeter (Honeywell W136A or equivalent) with 0 to 300 volt Vac scale.
2. Microammeter (Honeywell W136A or equivalent) with 0 to 25 microamp range SPL damping.
3. Meter connector plug part no. 117053 or equivalent (required for same meters).
4. Replacement parts – see Replacement and Accessories sections.

#### Preliminary procedures for model C7076A

### CAUTION

If the combustion chamber has a positive pressure, make sure the aspirator inlet pressure equals or exceeds that required for sight pipe seal off, as given on Figure 11. before unlatching the detector.

1. If you are using remote sensitivity selection, make sure that the external selector switch is *open* if adjusting sensitivity control A, or *closed* if adjusting sensitivity control B.
2. Unlatch the detector and swing it away from the face plate.
3. Loosen the 4 captive screws in the front cover plate (with the viewing lens) and remove the plate to expose the terminal block. The wiring diagram is on the inside of the front cover plate.
4. After *each* step in the following procedures, relatch the detector to the faceplate and check for

a meter reading at the FLAME CURRENT jack on the detector (Figure 17. ).

- a. If you get a reading above 1.4 microamps and the flame relay (in the flame safeguard control) pulls in, return to Sensitivity Adjustments.
- b. If you do not get a reading, unlatch the detector and proceed with procedure A. (Troubleshooting Procedures for model C7076A and C7076F)
- c. If you get a reading but the flame relay (in the flame safeguard control) does *not* pull in, unlatch the detector and proceed with Procedure B. (Troubleshooting procedures for model C7076A and C7076F)

#### Preliminary procedures for model C7076F

### WARNING

Ensure that the environment surrounding the C7076F is free of all explosive or hazardous conditions before exposing the interior of the detector to the atmosphere during the performance of the following troubleshooting procedures.

1. If you are using remote sensitivity selection, make sure that the external selector switch is *open* if adjusting sensitivity control A, or *closed* if adjusting sensitivity control B.
2. Loosen the 2 hexagon locking nuts of housing and the 4 hexagon locking nuts of the gland, which secures the rear cover plate of the detector. Turn the gland counter-clockwise, making sure that the rear cover plate with the cable glands stay in place to provide access to the FLAME CURRENT jack on the electronic chassis
3. After *each* step in the following procedures, realign the detector to the sight pipe and check for a meter reading at the FLAME CURRENT jack on the detector (Figure 17. ).
  - a. If you get a reading above 1.4 microamps and the flame relay (in the flame safeguard control) pulls in, return to Sensitivity Adjustments.
  - b. If you do not get a reading, unlatch the detector and proceed with Procedure A (Troubleshooting procedures for model C7076A and C7076F) .
  - c. If you get a reading but the flame relay (in the flame safeguard control) does *not* pull in, unlatch the detector and proceed with Procedure B, (Troubleshooting procedures for model C7076A and C7076F) .

## Troubleshooting procedures for model C7076A and C7076F

NOTE: If the detector develops a signal at the FLAME CURRENT jack, skip Procedure A.

### Procedure A: Zero flame signal reading at detector (flame relay does not pull in)

1. Complete the Preliminary procedures for model C7076A or model C7076F, as applicable, described above. Refer to the wiring diagram on the inside of the front cover plate (model C7076A only) or to Figure 14. or 15. for terminal locations
2. Check for proper line voltage. Connect an ac voltmeter across terminal 2 and 1 (or 8, if detector is non-European 240-volt, 50/60Hz. model) on the terminal block. Make sure the ac voltage measured is within the voltage range listed in the table below for particular detector model used. (The nominal voltage rating is printed on the transformer cover next to the sensitivity controls on the rear of the plug-in electronic chassis).
  - a. If there is no voltage, make sure line voltage power is connected to the master switch, the master switch is closed and overload protection (circuit breaker, fuse, or similar device) has not opened the power circuit.
  - b. If the measured voltage is not within the proper voltage range, make sure the main power supply is of the correct voltage and frequency. Then trace the wiring between the detector and the main power supply to determine the problem.

**Table 4. Acceptable voltage range**

Nominal Voltage Rating	Acceptable Line Voltage	
	Minimum	Maximum
100	85	110
117	99.5	128.7
120	102	132
200	170	220
220/240	187	264
240	204	264

3. Determine if the self-checking shutter is *open* by looking in the front of the detector through the pipe in the wiring compartment.
  - a. *If the shutter is not open*, connect an ac voltmeter across terminals 3 and 4 on the terminal block.

Make sure the ac voltage measured is within the voltage range listed in the table below for particular detector model used. (The nominal voltage rating is printed on the transformer cover next to the sensitivity controls on the rear of the plug-in electronics chassis).

**Table 5. Acceptable shutter voltage**

Nominal Detector Voltage Rating	Acceptable Shutter Voltage	
	Minimum	Maximum
100	85	110
117, 120, 200, 220, 240, or 220/240	99.5	132

1. If the proper voltage *is* present, replace the coil and shutter assembly or the entire plug-in electronics chassis (see Service section)
2. If the measured voltage is *not* within the proper voltage range, connect a dc voltmeter (capable of measuring 50 volts) across terminal 6(F) and 5(G) on the terminal block (F is +, G is -)
  - If the voltage is 2 volts or more, replace the plug-in electronic chassis (see Service section).
  - If the voltage is less than 2 volts, trace the shutter wiring between the detector and flame safeguard control (refer to figure). If the wiring is correct but proper voltage is still not present, replace the plug-in R7476\* or R7886A\* Dynamic Self-Check Ultraviolet Amplifier.
- \* See Table 2. Applicable flame signal amplifiers on page 4.
  - b. *If the shutter is open*, make sure the sensitivity control on the plug-in electronics chassis is not set too low for the flame conditions encountered. (Refer to Adjustments and Checkout section).
4. Make sure the viewing path is clear.
  - a. Clean the sight pipe. Make sure there are no obstructions in it.
  - b. Make sure the proper magnifying lens is used.
 

NOTE: Window glass does not transmit ultraviolet radiation. You can check for an improper lens by testing the detector with the lens *removed*.
  - c. Clean the lens with a soft clean cloth.
5. If the previous actions have not corrected the problem, replace the 191053 ultraviolet sensing tube (see Service section).
6. If you still do not get a meter reading, replace the plug-in electronics chassis.

**Procedure B: Flame signal reading present at detector  
(flame relay does not pull in)**

1. Complete the Preliminary procedures for model C7076A or model C7076F, as applicable, described above.
2. Determine if the self-checking shutter is *closed* by looking into the front of the detector through the pipe in the wiring compartment. If the shutter is closed and the signal at the FLAME CURRENT jack on the detector is 1 microamp or more, remove the ultraviolet sensing tube (see Service section).
  - a. If the shutter opens, replace the 191053 ultraviolet sensing tube.
  - b. If the shutter stays closed, replace the plug-in electronics chassis (see Service section).
3. If the flame signal measured at the FLAME CURRENT jack on the detector is *weak* (less than 1.4 microamps) proceed as follows:
  - a. Clean the sight pipe. Make sure there are no obstructions in it.
  - b. Clean the lens and viewing window (C7076F only) with a soft clean cloth.
  - c. Make sure the sensitivity control on the plug-in chassis is not set too low for the flame conditions encountered. (Refer to Adjustments and checkout section).
  - d. Resight the detector. See Planning the installation section.
4. If the flame signal measured at the FLAME CURRENT jack on the detector is *strong* (greater than 1.4 microamps) but the flame relay does not pull in, connect a dc voltmeter (capable of measuring 50 volts) across terminals 6(F) and 5(G) on the terminal block (F is +. G is -).
  - a. If the voltage is less than 5 volts and the shutter is *not* oscillating, disconnect the "F" leadwire from terminal 6 for a moment.
    1. If the voltage (5 to 6) rises, trace the wiring between the detector and flame safeguard control (refer to Figure 14. ). If the wiring is correct (no "shorts"), replace the plug-in R7476\* or R7886\* Dynamic Self-Check Ultraviolet Amplifier.
    2. If the voltage (F to G) does *not* rise, replace the plug-in electronics chassis (see Service section).
  - b. If the voltage is 5 volts or more, check the F and G leadwires between the detector and the flame safeguard control. If they are wired properly (no "opens"), replace the plug-in R7476\* or R7886A Dynamic Self-Check Ultraviolet Amplifier.
5. If the previous actions have not corrected the problem, replace the plug-in electronics chassis.

\* See Table 2. Applicable flame signal amplifiers on page 4.

## SERVICE

### CAUTION

1. Only qualified servicemen should attempt to service or repair flame safeguard controls and burner management systems.
2. Model C7076A only: if the combustion chamber has a positive pressure, make sure the airflow through the aspirator equals or exceeds the value for seal-off (Figure 11. ) before unlatching the detector.
3. Open the master switch before removing or installing the plug-in electronics chassis of the detector.

### WARNING

**For Model C7076F only:** Ensure that the environment surrounding the C7076F is free of all explosive or hazardous conditions or remove all power from the detector, before exposing the interior of the detector to the atmosphere during performance of the following service procedures.

### Periodic maintenance

1. Scheduled replacement of detector components is *not necessary*.
2. Keep the flame detection system adjusted for safe and reliable operation
3. Clean the magnifying lens and viewing window (C7076F only) regularly. Use a soft, clean cloth. If the lens/viewing window is damaged, or it is coated with a substance which cannot be cleaned off, replace it (model C7076A only, see Maintenance Procedures below).
4. Model C7076F only: replace the silicone-rubber O-rings, which seal the front and rear cover plates, if they are damaged or deteriorated (see Maintenance procedures below).

### Maintenance procedures

### WARNING

Before making a replacement, make sure you have the correct part (check its part number and voltage rating).

#### Replacing the plug-in electronics chassis in model C7076A

1. *Open the master switch* to interrupt all power to the detector.
2. Loosen the 4 captive screws in the rear cover plate and remove the plate.
3. Remove the 4 standoffs that hold the plug-in electronics chassis and pull the chassis out of the housing.
4. Align the slot in the top of the new chassis with the key in the housing. (Make sure the part number and voltage rating of the new chassis are correct).

5. Insert the new chassis in the housing and firmly push it all the way in. Make sure the octal plug on the chassis is securely seated in the socket in the housing.
6. Insert the 4 standoffs that hold the chassis and tighten them securely.
7. Close the master switch and perform the Adjustment and Checkout.
8. Put the rear cover plate back on and tighten the 4 screws securely.

#### Replacing the plug-in electronics chassis in model C7076F

1. *Open the master switch* to interrupt all power to the detector.
2. Loosen the 2 hexagon locking nuts of housing and the 4 hexagon locking nuts of the gland, which secures the rear cover plate of the detector.
3. Turn the gland counter-clockwise to provide access to terminal block of the detector. Make sure that the rear cover plate with the cable glands stay in place
4. Remove the 2 fixing screws of the terminal mounting rail that holds the plug-in electronics chassis and pull the chassis out of the housing.
5. Insert the new chassis in the housing and firmly push it all the way in. Make sure the octal plug on the chassis is securely seated in the socket in the housing.
6. Replace the terminal mounting rail and tight the fixing screws with spring washers securely.
7. Close the master switch and perform the Adjustment and Checkout procedures previously specified.
8. Reassemble detector by performing step 2. above in reverse.

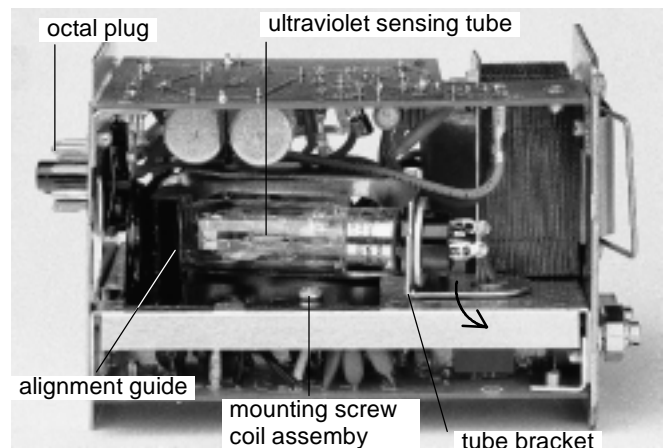

**Fig. 19. Top view plug-in electronic chassis**

#### Replacing the ultraviolet sensing tube

1. *Open the master switch* and remove the plug-in electronics chassis as specified in above paragraph entitled "Replacing the Plug-in Electronics Chassis in model C7076A or model C7076F, as applicable".
2. Locate the sensing tube near the top of the chassis (Figure 19. ).
3. Gently push the alignment guide away from the tube until the tip of the tube is free.
4. While holding the alignment guide away from the tube tip, grasp the tab on the tube bracket and swing the tube out from the chassis.

5. Pull the tube out of its socket.
6. Align the 3 pins on the new tube firmly into the socket. Make sure it is seated securely.
7. Swing the tube back into place in the chassis. The alignment guide will snap into place around the tip of the tube.
8. Reinstall the plug-in electronics chassis as specified in above "Replacing the plug-in electronics chassis".
9. Close the master switch and perform the adjustments and checkout.

**IMPORTANT**

Be very careful not to kink or otherwise damage the shutter.

**Replacing the coil and shutter assembly**

1. *Open the master switch* and remove the plug-in electronics chassis as specified in above paragraph entitled "Replacing the plug-in electronics chassis in model C7076A or model C7076F, as applicable".
2. Locate the coil near the bottom of the chassis (Figure 20. ).
3. Cut the 2 white coil wires (connected to the octal plug) as close to the coil as possible.
4. Remove the mounting screw (Figure 19. ) from the base of the coil and shutter assembly.
5. Turn the chassis over and locate the sensing tube.
6. Gently push the alignment guide away from the tube (just enough to free the tip of the sensing tube) and swing the tube out from the chassis as far as it will go (Figure 19. )
7. Remove the other mounting screw (Figure 19. ) from the base of the coil and shutter assembly.
8. Carefully slide the coil and the shutter out of the chassis.  
NOTE: It may be necessary to move some of the transformer lead wires out of the way in order to slide the coil and the shutter assembly past them.
9. Slide the new coil and shutter assembly into place. (Make sure its part number and voltage rating are correct).
10. Remove about 6 mm (1/4 inch) of insulation from each of the 2 short, white lead wires still connected to the octal plug.
11. Using wire nuts, connect one of the coil wires to one of the short, white lead wires on the plug and connect the other coil wire to the short, white lead wire.
12. Insert the 2 mounting screws in the base of the coil and shutter assembly and tighten them securely.
13. Swing the sensing tube back into place in the chassis,. The alignment guide will snap into place around the tip of the tube.
14. Reinstall the plug-in electronics chassis as specified in above paragraph entitled "Replacing the plug-in electronics chassis in model C7076A or model C7076F, as applicable".
15. Close the master switch.

**IMPORTANT**

Be very careful to kink or otherwise damage the shutter.

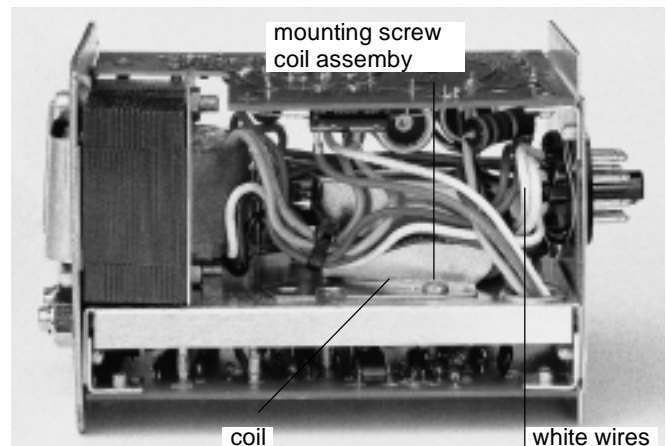

**Fig. 20. Bottom view plug-in electronic chassis**

**Replacing the viewing lens (model C7076A only)**

1. *Open the master switch* to interrupt all power to the detector
2. If the combustion chamber has a positive pressure, make sure the airflow through the aspirator equals or exceeds the value required for seal-off (Figure 11. ).
3. Unlatch the detector and swing it away from the faceplate-aspirator.
4. Loosen the 4 captive screws in the front cover plate and remove the plate.
5. Press on the back of the silicone-rubber grommet until it pops out of the cover plate.
6. Push on the back of the lens until it pops out of the grommet.
7. Insert the new lens, *flat side toward the grommet's small flange and curved side toward the flame*, into the recess in the grommet. Make sure the recess completely encloses the lens.
8. Push the small flange of the grommet through the hole in the cover plate until it pops into place. make sure the flange is completely through the hole and the grommet is properly seated.
9. Clean both sides of the viewing lens with a soft, clean cloth.
10. Put the front cover plate back on and tighten the 4 screws securely.
11. Latch the detector against the faceplate-aspirator and close the master switch.

**Replacing the gasket seals (model C7076A only)**

1. *Open the master switch* to interrupt all power to the detector.
2. If the combustion chamber has a positive pressure, make sure the airflow through the aspirator equals or exceeds the value required for seal-off (Figure 11. ).
3. Unlatch the detector and swing it away from the faceplate-aspirator.
4. Loosen the 4 captive screws in the front cover and remove the plate.
5. Using a putty knife, carefully separate the silicone-rubber gasket from the inside of the plate
6. Pull the gasket over the ends of the 4 screws and discard it.
7. Scrape off any residual adhesive from the plate, leaving a smooth surface to which the new gasket can adhere.

8. Insert the 4 screws through the holes in the corner of the new gasket.
9. Glue the new gasket to the plate, using a good silicone rubber adhesive (such as RTV732). Follow the instructions with the adhesive.
10. Put the cover plate back on and tighten the 4 screws securely.
11. Repeat steps 4. through 10. for the rear cover.
12. Latch the detector against the faceplate aspirator and close the master switch.

## STANDARDS AND APPROVALS

### Models C7076A and F

C7076A and F Ultraviolet Flame Detector conform with following EC-Directives:

- Gas Appliance Directive (90/396/EEC).

according to European standard:

EN298 approved with R7886A\* and R7476\* flame amplifiers.

\* See Table 2. Applicable flame signal amplifiers on page 4.

- Low Voltage Directive (73/23/EEC)

according to European standard:

EN60730-2-5

- Electro Magnetic Compatibility Directive (89/336/EEC)

according European standards:

EN55011 class B regarding emission.

EN50082-2 industrial level regarding immunity.

### Model C7076F

In addition to above information, C7076F conforms with:

- Explosive Atmospheres Directive (94/9/EC)

according to European standards:

EN50014

EN50018

EN50019

For further details see table 6.

### Other approvals (C7076A only)

Underwriters Laboratories Inc. Listed (120 model only):

File No. MP268, Guide No. MCCZ.

Canadian Standards Association Certified (120 models only):

File No. LR1620.

Factory Mutual Approved: Report No. FM26980.

Industrial Risk Insurers acceptable

Further details can be found in the Approvals List.

**Table 6. list of Ex certificates of model C7076F**

Description	Type	Manufacturer	Certificate	Ex classification
EExd housing	8214/123-1-604-S	Stahl	PTB Nr. Ex-88.B. 1067	EEx d IIC T6
Bras cable gland	EMDB-A12-M25	Electromach	KEMA Nr. Ex-93.C. 6952	EExdell
Cable dia. reducer	EMDB-A9	Electromach	KEMA Nr. Ex-93.C. 6952	EExdell
Stopping plug	PLG-M25	Redapt	BASEEFA Nr. Ex-831218U	EEx d IIC



## Physikalisch-Technische Bundesanstalt

**KONFORMITÄTSMESSEINHEITUNG**

PTB Nr. Ex-88.0-1067

(1) Diese Bescheinigung ist zu verwenden für die Messung der ...  
Steuerung 1... (A/1...-2...)

(2) der Firma ...  
Stahl-Schaltgeräte GmbH  
Postfach 7110, ...

(3) Die Bauart dieses angetriebenen Bauelementes sowie die verschiedenen zulässigen Ausführungen und in der Anlage zu dieser Konformitätsbescheinigung festgelegt.

(4) Die physikalisch-technische Bundesanstalt bescheinigt als Prüfstelle nach Artikel 14 der Richtlinie des Rates der Europäischen Gemeinschaften vom 18. Dezember 1975 (76/117/EWG) die Übereinstimmung dieses elektrischen Bauelementes mit den harmonisierten Europäischen Normen:

**Elektrische Betriebsmittel für explosionsgefährdete Bereiche**

EN 50 018:1977 + A1...A2 (N02 0120/0171) bis 11 175-08) Allgemeine Bestimmungen  
 EN 50 018:1977 + A1...A2 (N02 0120/0171 bis 11 575-08) Druckfeste Kopplung "p"  
 EN 50 025:1977 + A1...A2 (N02 0120/0171 bis 11 677-08) Ermittelte Störleistung "p"

nachdem das Bauelement mit Erfolg einer Bauartprüfung unterzogen wurde. Die Ergebnisse dieser Bauartprüfung sind in einem vertraulichen Protokoll festgelegt.

(7) Das Bauelemente ist mit dem folgenden Kennzeichen zu versehen:

**EEC 16 Ex II oder EEx de IIC 16 Ex II 15**

(8) Der Hersteller ist zu verpflichten, daß jedes damit gekennzeichnete Bauelement in seiner Bauart mit der in der Anlage zu dieser Bescheinigung aufgeführten Prüfungsanforderungen übereinstimmt und daß die entsprechenden Prüfungen erfolgreich durchgeführt werden.

(9) Das elektrische Bauelement darf mit dem hier abgedrucktem gemeinschaftlichen Unterscheidungszeichen gemäß Anhang I der Richtlinie des Rates vom 6. Februar 1976 (76/196/EWG) gekennzeichnet werden.

Im Auftrag  
  
 Dr.-Ing. Mehning

Braunschweig, 15.03.1989

Anlage zur Konformitätsbescheinigung für ...  
 Konformitätsbescheinigung für ...  
 Anlage zur Konformitätsbescheinigung für ...

## Physikalisch-Technische Bundesanstalt

Anlage zur Konformitätsbescheinigung PTB Nr. Ex-88.0-1067

**Stückprüfung**

Durch Stückprüfung gemäß EN 50 014 Abschnitt 22.5.6.1 und den Festlegungen in den Prüfungsunterlagen ist die Temperaturklasse festzulegen.

**Prüfungsergebnisse**

1. Beschreibung (5 Blatt) ... unterzogen am 03.11.1988

Im Auftrag  
  
 Dr.-Ing. Mehning

Braunschweig, 15.03.1989

Blatt 2/2

## electromach bv

projecten, besturingstechnieken en componenten

postbus 175  
7550 ad hengelo, holland

hamerstraat 10  
7556 mz hengelo, holland



### MANUFACTURERS DECLARATION

We, **electromach bv**, herewith declare :

The Honeywell flameproof Ultraviolet Flamedetector Model C7076F, executed in a flameproof enclosure make Stahl type 8214/123-2-604-S is suitable for a temperature-range of  $-40^{\circ}$  till  $+70^{\circ}\text{C}$ .

This declaration is based on the underneath mentioned points :

- The gasketmaterials are suitable for an ambient temperature above  $100^{\circ}\text{C}$ .
- The heat-dissipation of the built in electronic components is so low that even at an ambient temperature of  $+70^{\circ}\text{C}$  the outertemperature of the enclosure remains below  $+85^{\circ}\text{C}$  (T6).

Note : To avoid damaging of the gaskets it is recommended not to open the enclosure at an ambient temperature below  $-20^{\circ}\text{C}$ .

februari 1997  
**electromach bv**

W.H. Moelard  
Quality Manager

tel.: 074 - 2472472  
telex: 44328 emho nl  
telefax: 074 - 2435925

bank: rekeningnr./accountno.  
abn\*amro: 59.01.14.573  
postbank: 10.24.401  
k.v.k. enschede: no. 06040491



alle leveringen geschieden overeenkomstig de leveringsvoorwaarden, gedeponeerd bij de k.v.k. te enschede

**KEMA** 

ANNEX

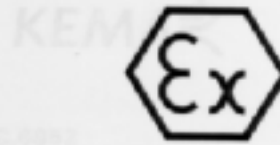

to Certificate of Conformity KEMA No. Ex-93.C.6952

(1) **CERTIFICATE OF CONFORMITY**

(2) **KEMA No. Ex-93.C.6952**

(3) This certificate is issued for the electrical apparatus:

**Cable entries Type EMD . - A . - . , EMD . - B . - . and EMD . - S . - .**

(4) **Manufacturer:**

**Electromach bv  
Hamerstraat 10  
7556 MZ Hengelo  
The Netherlands**

(5) This electrical apparatus and any acceptable variation thereto is specified in the Annex to this certificate and the documents therein referred to.

(6) KEMA, being an Approved Certification Body in accordance with Article 14 of the Council Directive of the European Communities of 18 December 1975 (76/117/EEC), confirms that the apparatus has been found to comply with the harmonised European standards:

**Electrical apparatus for potentially explosive atmospheres**  
**EN 50 014 : 1977 + A1 ... A5, General requirements**  
**EN 50 018 : 1977 + A1 ... A3, Flameproof enclosure "d"**  
**EN 50 019 : 1977 + A1 ... A3, Increased safety "e"**

and has successfully met the examination and test requirements which are recorded in a confidential test report.

(7) The apparatus marking shall include the code:

**EEx de IIC**

(8) The supplier of the electrical apparatus referred to in this certificate, has the responsibility to ensure that the apparatus conforms to the specification laid down in the Annex to this certificate and has satisfied routine verifications and tests specified therein.

(9) This apparatus may be marked with the Distinctive Community Mark specified in Annex II to the Commission Directive of 16 January 1984 (84/47/EEC).

Amhem, 16 March 1994  
by order of the Board of Directors of N.V. KEMA

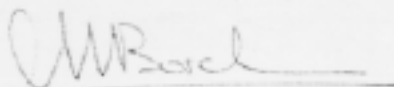

**C.M. Boschloo**  
Certification Manager

This Certificate including the Annex forms an inseparable whole; reproduction in abridged or modified form is not permitted

**N.V. KEMA**

Directieweg 310, 6812 AR Amhem, P.O. Box 9006, 6800 ST Amhem, The Netherlands  
Telephone (+31) 05 56 28 50, Telefax (+31) 05 51 49 22, Telex 45016 kema nl, 45715 kashol

Page 1/1



# BASEEFA

British Approvals Service for Electrical Equipment in Flammable Atmospheres

## 1 COMPONENT CERTIFICATE

2 BAS No Ex 831218U dated 20 June 1983

3 This certificate is issued for the electrical apparatus:

FLAMEPROOF STOPPING PLUG

4 manufactured and submitted by

REDAPT ENGINEERING CO LTD  
of Darlaston, West Midlands

5.1 The component must be designed and constructed in accordance with the specification set out in the Schedule or Schedules attached hereto and in the documents referred to therein.

5.2 The document should not in any way be construed as a Certificate of Conformity or an Inspection Certificate but it may be used by a Certification Authority to establish the acceptability of the component for use as a component part of equipment which is certified by either a Certificate of Conformity or an Inspection Certificate.

5.3 Insofar as the component used in an equipment subject to certification is identical with the one forming the subject of the present Component Certificate, reference in a Certificate of Conformity or an Inspection Certificate to the Number of this Component Certificate will suffice to specify the characteristics detailed in this document without the need for collection of documents or repetition of the examinations and tests detailed herein. This does not preclude a requirement for any supplementary tests which may be necessary as a function of the use of the component e.g. distances from enclosure walls, heating, etc.







5.4 This Certificate is valid for three years from the date of issue unless previously suspended or revoked.

Code: EEx d IIC

Test Report No 83(d)103  
dated 10 June 1983





File: SFA/19/218/02



 MECS		 BASEEFA
<h2>Licence</h2> <p>Number M0868</p>		
<p>I hereby authorise</p>		
<p><b>REDAPT ENGINEERING CO LIMITED</b> Units 46 and 47 Darlaston Central Trading Estate Salisbury Street Darlaston WS10 8XB</p>		
<p>to reproduce the licensed marks specified in Schedule 1 of this Licence on electrical equipment defined in the Certificates listed in Schedule 2 of this Licence, subject to compliance with the rules of the EECS Conformity Assurance Programme Licensing Scheme for Certified Explosion Protected Electrical Equipment.</p>		
<p>This Licence is valid until 1 December 1999 unless previously suspended or revoked in accordance with the rules of the Scheme.</p>		
 <b>I M CLEARE</b> DIRECTOR 1 December 1996		
	<p>Electrical Equipment Certification Service Health and Safety Executive Harpur Hill, Buxton, Derbyshire, SK17 9JN, United Kingdom Tel: 01298 28000 Fax: 01298 28244</p>	 <small>The use of the Accreditation Mark indicates accreditation in respect of those activities covered by the accreditation certificate number 024.</small>



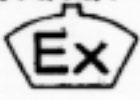

Sheet 1 of 3

CERTIFICATE ISSUE 1 DATED APRIL 96

 MECS		 BASEEFA
<h2>Licence</h2>		
<b>Number M0868</b>		
<b>Schedule 1</b>		
<b>Marks which may be applied by the Licensee</b>		
<i>Note : The Marks are described in Annex 1 of the Rules of the EECS Conformity Assurance Programme Licensing Scheme for Certified Explosion Protected Electrical Equipment</i>		
<b>Explosion protection concepts for which the Licensee has been assessed</b>		
Flameproof enclosure (d) Increased safety (e)		
<b>Equipment Types for which the Licensee has been assessed</b>		
<i>Note : The Equipment Types are given in Annex 3 of the Rules of EECS Conformity Assurance Programme Licensing Scheme for Certified Explosion Protected Electrical Equipment</i>		
Cable attachments - plugs, sockets, glands, fittings Motors, generators, linear and rotary actuators		
Schedule Number M0868/1/1		Dated 1 December 1996
	<b>Electrical Equipment Certification Service</b> Health and Safety Executive Harpur Hill, Buxton, Derbyshire, SK17 9JH, United Kingdom Tel: 01298 28000 Fax: 01298 28244	 The use of the Accreditation Mark indicates compliance in respect of those activities covered by the accreditation certificate number 951.

Sheet 2 of 3

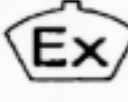
CERT/0000/LICENCE ISSUE 1 DATED APRIL 96

 MECS		 BASEEFA
<b>Licence</b> Number M0868 Schedule 2		
<b>Component certificates, approvals and acceptances included with the Licence</b>		
<i>Note: The Licence is not permitted to reproduce the licensed marks on the components</i>		
<b>Group II</b>		
Ex 831216U    Ex 831218U    Ex 87B3481U    Ex 89Y1404U		
Schedule Number M0868/2/1    Dated 1 December 1996		
	<b>Electrical Equipment Certification Service</b> Health and Safety Executive Harpur Hill, Buxton, Derbyshire, SK17 8JN, United Kingdom Tel: 01298 28000    Fax: 01298 28244	 The use of the Accreditation Mark indicates conformance to a standard approved by the accreditation authority number 626.

Sheet 3 of 3

CONFIDENCE ISSUE DATED APRIL 96

## ORDERING INFORMATION

When ordering specify:

- Model number.
- Voltage and frequency.

Order separately:

- R7476\* Dynamic Self-Check Ultraviolet Amplifier.
- R7888A\* Dynamic Self-Check Ultraviolet Amplifier.
- Replacement parts, if desired.
- Accessories, if desired
- \* See Table 2. Applicable flame signal amplifiers on page 4.



## REPLACEMENT PARTS AND ACCESSORIES

### Replacement parts for model C7076A

O.S. number	Description
191054	gasket for front and rear cover plates
191002A	100 Vac 50/60 Hz plug-in electronic chassis <sup>1)</sup>
191002B	110 ... 120 Vac 50/60 Hz plug-in electronic chassis <sup>1)</sup>
191002D	220/240 Vac 50/60 Hz plug-in electronic chassis <sup>1)</sup>
190971E	coil and shutter assembly for all models <sup>2)</sup>
190971F	coil and shutter assembly for 100 V model
191050	magnifying lens
191053	ultraviolet sensing tube
190999	grommet for magnifying lens

1) without ultraviolet sensing tube

2) except 100 V model

### Replacement parts for model C7076F only

O.S. number	Description
5157520	O-ring for front and rear cover plates
191002AF	100 Vac 50/60 Hz plug-in electronic chassis <sup>1)</sup>
191002BF	110 ... 120 Vac 50/60 Hz plug-in electronic chassis <sup>1)</sup>
191002DF	220 /240 Vac 50/60 Hz plug-in electronic chassis <sup>1)</sup>
190971E	coil and shutter assembly for all models <sup>2)</sup>
190971F	coil and shutter assembly for 100 V model
191050	magnifying lens
191053	ultraviolet sensing tube
190999	grommet for magnifying lens

1) without ultraviolet sensing tube

2) except 100 V model

### Accessories for model C7076A

O.S. number	Description
118367A	swivel mount
190998A	aspirator assembly
191203-007 67	hinge
191205	pin and chain

### Accessories for model C7076A and model C7076F

O.S. number	Description
196146	meter connector plug-for older W136A models
W136A	test meter-includes 196146 meter connector plug
30394510	brass adapter, 1 inch NPT to 1 inch BSP.PI